

编号 RFL-C3300X~RFL-C15000

密级 内 1

阶段标记 S

页数 39

名称 RFL-C3300X/RFL-C4000X/RFL-C6000X/  
RFL-C8000X/RFL-C10000X/RFL-C12000X/  
RFL-C15000

连续光纤激光器英文说明书

会签

单位 武汉锐科-第二事业部

编写 \_\_\_\_\_

校对 \_\_\_\_\_

审核 \_\_\_\_\_

标审 \_\_\_\_\_

批准 \_\_\_\_\_

武汉锐科光纤激光技术股份有限公司



# **High Power Continuous Wave Fiber Laser Instructions**

<b>Applicable</b>	<b>RFL-C3300X</b>	<b>RFL-C4000X</b>	<b>RFL-C6000X</b>
<b>models:</b>	<b>RFL-C8000X</b>	<b>RFL-C10000X</b>	<b>RFL-C12000X</b>
	<b>RFL-C15000</b>		

# CONTENTS

<b>1 Safety Information.....</b>	<b>1</b>
1.1 Security Label.....	1
1.2 Laser Safety Grade.....	2
1.3 Optical Safety.....	2
1.4 Electrical Safety.....	2
1.5 Other Safety Rules.....	3
<b>2 Product Description.....</b>	<b>4</b>
2.1 Features.....	4
2.2 Package Parts.....	4
2.3 Unpacking and Inspection.....	4
2.4 Operation Environment.....	5
2.5 Attentions.....	6
2.6 Specifications.....	6
<b>3 Installation.....</b>	<b>8</b>
3.1 Dimensions.....	8
3.2 Installation rule.....	13
3.3 Cooling Requirements.....	15
<b>4 Using the Product.....</b>	<b>17</b>
4.1 Front Panel.....	17
4.2 Rear Panel.....	18
4.3 Power Connection.....	22
4.4 Interface Definitions.....	24
4.5 Operation Mode and Control.....	27
4.6 Entering a Control Mode.....	27
4.7 Serial Port Communication Mode.....	28
4.7.1 Cable Connection of Serial Port Communication Mode.....	29
4.7.2 Operations in Serial Port Communication Mode.....	29
4.8 RS-232 mode.....	32
4.8.1 Wiring in RS-232 Mode.....	32
4.8.2 Communication Protocol.....	33
4.8.3 The Operation in RS-232 Mode.....	33
4.9 AD mode.....	34
4.9.1 Wiring in AD mode.....	34
4.9.2 The operations in AD mode.....	34
4.10 Red Light Control.....	35
4.11 Water flow monitoring.....	36





4.12 Real-time power feedback.....	37
4.13 Light out fault locking.....	37
<b>5 Alarms and Possible Solutions.....</b>	<b>37</b>
5.1 Read Alarm Logs.....	37
5.2 Alarm Solutions.....	38
<b>6 Warranty, Repair and Return.....</b>	<b>40</b>
6.1 General Warranty.....	40
6.2 Limitations of Warranty.....	40
6.3 Service and Repair.....	41







## 1 Safety Information

Thank you for choosing Raycus Fiber Laser. This user manual provides you with important safety, operation, maintenance and other relevant information. Please read the manual carefully before using this product. To ensure safe operation and optimum product operation, please observe the following cautions and warnings as well as other information within this manual.

### 1.1 Security Label

	<p><b>WARNING:</b> Describes a hazard that lead to severe injury or death to people.</p>
---	--

	<p><b>CAUTION:</b> Describes a hazard that lead to general injury to people or damage to product.</p>
--	---

		
<p>1: Laser Emit Head</p>	<p>2: Type 4 Laser Product</p>	<p>3: Class 2M Laser Product Label-2mW Red Laser</p>
		
<p>4: CE Authentication</p>	<p>5: ID Label</p>	<p>6: Laser Radiation Hazard</p>
		
<p>7: Electrical Hazard</p>		

## 1.2 Laser Safety Grade

According to European Standard EN 60825-1, Clause 9, this series of lasers are Class 4 laser instruments. The product emits laser radiation at a wavelength of 1080 nm or around 1080 nm, and the average laser power radiated from the output head is 3.3 kW to 15 kW (depending on the machine model), either directly or indirectly exposed to high power laser radiation to the eye or skin damage. Although the radiant laser is not visible, the beam will cause irreparable damage to the retina or cornea, so appropriate and certified laser safety glasses must be worn throughout the laser emitting .

	<p><b>WARNING:</b> Users must use appropriate laser goggles when operating this device. The laser goggles should be selected according to the range of wavelength emitted from this product. Users must ensure that the protect range of laser goggles over the entire range of laser wavelengths. Please do not directly view the laser output head when laser emitting.</p>
---	---

## 1.3 Optical Safety

Any dust on the end of the collimator assembly can damage the lens or the entire laser device.

	<p><b>CAUTION:</b> DO NOT emit when the protective cap is not removed, otherwise the lens or crystal will be damaged.</p>
---	---

## 1.4 Electrical Safety

- 1) Ensure the product is grounded through the PE line of the AC power cord.  
The grounding must be firm and reliable.

	<p><b>WARNING:</b> Any interruption from the protective earth will electrify the enclosure, which may result in personal injury.</p>
---	--

- 2) Ensure that the AC voltage is supplied normally.



**CAUTION:** Wrong wiring mode or power supply voltage will cause an un recoverable damage to the laser device.

## 1.5 Other Safety Rules

- 1) Do not directly view the laser output head when laser emitting. Avoid using the laser in a dark environment.
- 2) Do not use fiber lasers in dark or dim environments.
- 3) If this device is used in a manner not specified in this document, the protection provided by the device may be impaired and the warranty will be voided.
- 4) There are no user serviceable parts, equipment or assemblies inside the product. All service and maintenance shall be conducted by Raycus engineer. In order to prevent electric shock, please do not break the seal or uncover the shield. Failure to comply with this instruction will be treated as out of the warranty.

## 2 Product Description

### 2.1 Features

Fiber lasers are more compact and ready to use than conventional laser structures, with higher electrical and optical conversion efficiencies, lower power consumption and better beam quality. Thanks to its flexible laser output, it can be easily integrated with system equipment.

Main Features:

- High beam quality
- High reliable
- Maintenance free operation
- High wall-plug efficiency
- Convenient control interface
- Fast modulation

Applications:

- Industrial cutting and welding
- Scientific research

### 2.2 Package Parts

Please refer to package accessories are in the packing box.

### 2.3 Unpacking and Inspection

Through the specially designed packaging materials and cabinets, Raycus ensures that the lasers are fully protected during transportation. Nevertheless, in order to prevent unpredictable situations during transportation, the users still needs to carefully check whether the package is correctly placed before unpacking, and there is no damage or phenomenon such as collision, cracking and flooding on the outside of the box. Once you find that there is an abnormality in the external cabinet, please inform Raycus Company in time to deal with it as soon as possible.



Please double check if each listed contents is inside the package; and contact Raycus as soon as possible if there is any issues.

Take extra care when removing the unit from the package to make the fiber optic cable stay away from collision and vibration. Please do NOT distort, bend or pull the output cable when unpacking the device; and avoid any collision to the head of laser output.

	<p><b>CAUTION:</b> The fiber optic cable and output head are precise optic instrument, ANY vibration or impact to the output head, and twist or excessive bend to the cable will damage the instrument.</p>
---	---

## 2.4 Operation Environment

The operation conditions are listed as the following table:

Table 1: The Operation Environment Conditions for the Laser

Model	C3300X	C4000X	C6000X	C8000X	C10000X	C12000X	C15000
Supply voltage (V)	Three-phase four-wire system AC 323V~AC 437V、50/60Hz (including PE)						
Power supply capacity (kVA)	>20	>25	>40	>50	>65	>80	>95
Water cooling flow (L/min)	>33	>43	>50	>60	>75	>90	>112
Installation Environment	Flat, no vibration nor impact						
Ambient Temperature	10°C~40°C						
Relative Humidity	≤70%						

- (1) Make sure the product is properly grounded before use.
- (2) The laser output head is connected with fiber optic cable. Please inspect the output head carefully for dust or other contaminations. Use appropriate lens paper to clean it if necessary.
- (3) Failure to follow the instructions when operating the laser may cause malfunction and damage.
- (4) It is not allowed to install the output head when the laser is in operation.

(5) Do not look into the output head directly. Wear appropriate protective eye glasses all the time when operating the laser.

Tips: Install the laser in an air-conditioned environment for longer life and better performance.

## 2.5 Attentions

- (1) Make sure that the correct voltage of 380VAC is used. Connecting failure of power supply will damage the device.
- (2) The output laser is collimated by the collimating lens, it is important to keep the collimating lens clean, otherwise it will damage the device.
- (3) Please cap the output head when it is not in use. Do not touch the output lens at any time. Use appropriate lens paper to clean it if necessary.
- (4) Safety keep the cap when using the laser. To avoid dust, make sure the opening direction of the cap is put down.
- (5) Failure to follow the instructions may cause laser power loss, such loss is not covered by warranty.

## 2.6 Specifications

Table 2 Product Specifications

Optical properties								Test Conditions
Model	C3300X	C4000X	C6000X	C8000X	C10000X	C120000X	C150000	
Output Power(kW)	3	4	6	8	10	12	15	/
Operation Mode	CW/Modulated							/
Polarization State	Random							/
Output Power Tunability(%)	10~100							/
Emission Wavelength(nm)	1080±5							Nominal Output Power

Output Power Unstability	±1.5%							Nominal Output Power; Duration: 5hrs; Ambient Temp.: 25°C
Modulation Frequency(Hz)	50~5k			50~2k				Nominal Output Power
Red Guide Laser Power(mW)	0.5~1							/
Fiber output Types	HQBH			QD				/
Beam Quality (BPP, mm•mrad)	< 4.5			< 5				Nominal Output Power
Divergence angle (rad)	≤ 0.1							Nominal Output Power
Fiber core diameter (μm)	100							customizable
Delivery Cable Length(m)	20		30			20		customizable
Electrical characteristics								
Operating Voltage	Three-phase four-wire system AC340V~AC420V、50/60Hz (Include PE)							/
Maximum power Consumption (kW)	9.5	12.5	18.5	24.5	30.5	36.5	45.5	/
Way to control	Serial communication / AD							/
Other characteristics								
Dimension (mm)	670×990×1160	900×960×1160		960×1020×1600		960×1220×1600		Includes casters and rings, without warning lights

Weight (kg)	<250	<280	<360	<400	<450	<500	<800	Air conditioning included
Operating Ambient Temperature (°C)	10~40							/
Humidity(%)	<70							/
Storage temperature (°C)	-10~60							/
Cooling method	Water cooling							/

### 3 Installation

#### 3.1 Dimensions

The mechanical appearance dimensions of RFLC3300X/ C4000X/ C6000X/ C8000X/ C10000X/ C12000X/ C15000 continuous wave fiber laser are as follow:

(1) The external dimensions of the RFL-C3300X/ C4000X continuous wave fiber laser are shown in Figure 1 (taking RFL-C3300X as an example).

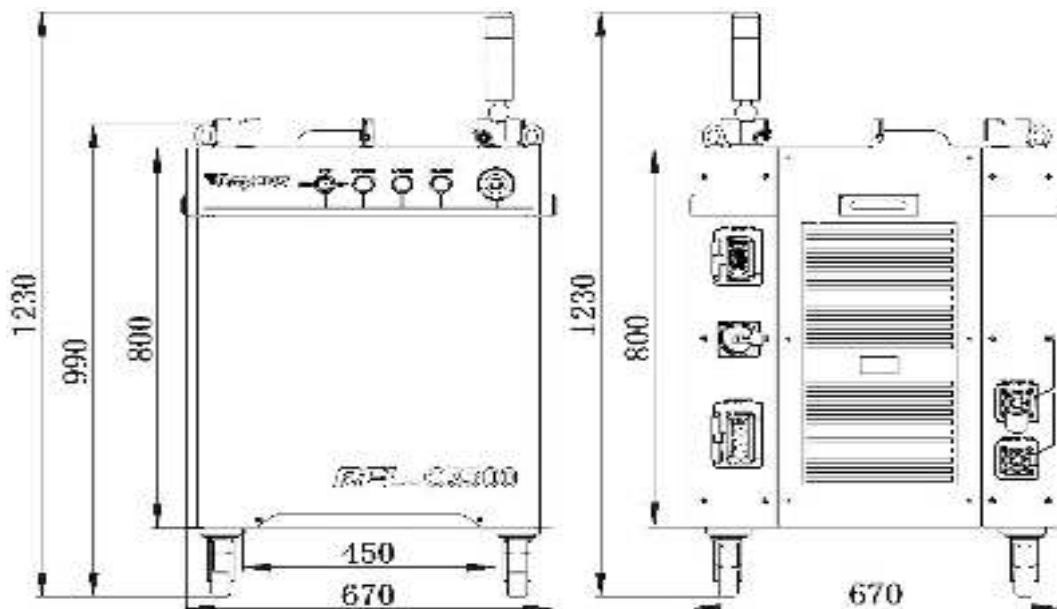

Figure 1-a Front and rear view of the laser.

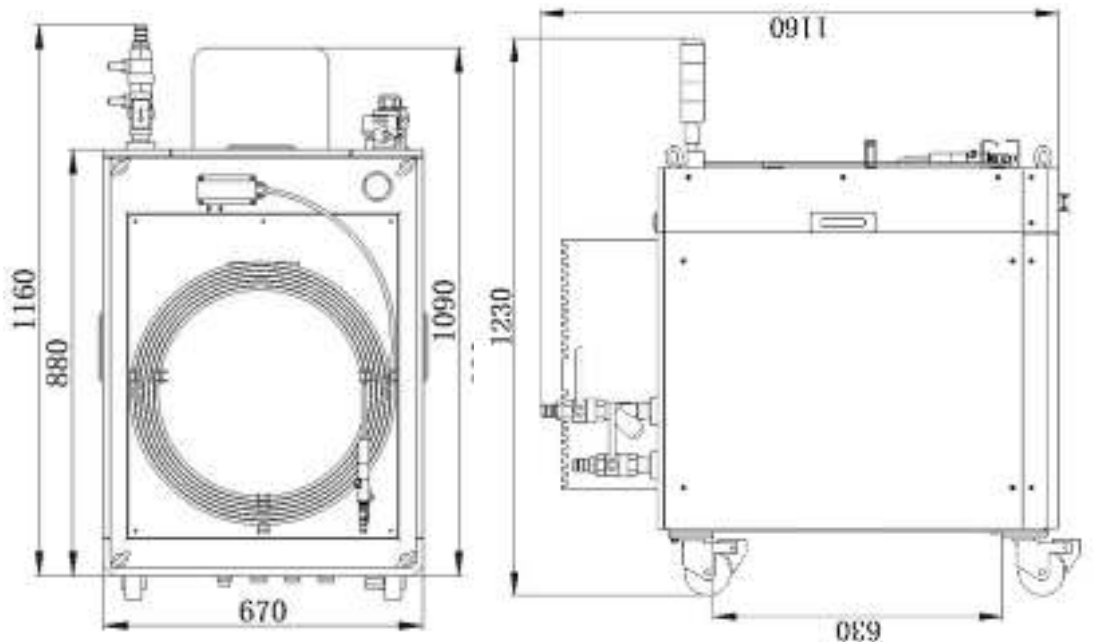

Figure 1-b Top and left view of the laser.

Figure 1 The dimensions of RFL-C3300X continuous fiber laser.

The RFL-C3300X/ C4000X two lasers share a set of cabinets.

Model	RFL-C3300X	RFL-4000X
N.W	250kg	280kg
Dimensions	670*990*1160mm(L×W×H)	

(2) The dimensions of the RFL-C6000X / C8000X continuous wave fiber laser are shown in Figure 2 (taking RFL-C6000X as an example).

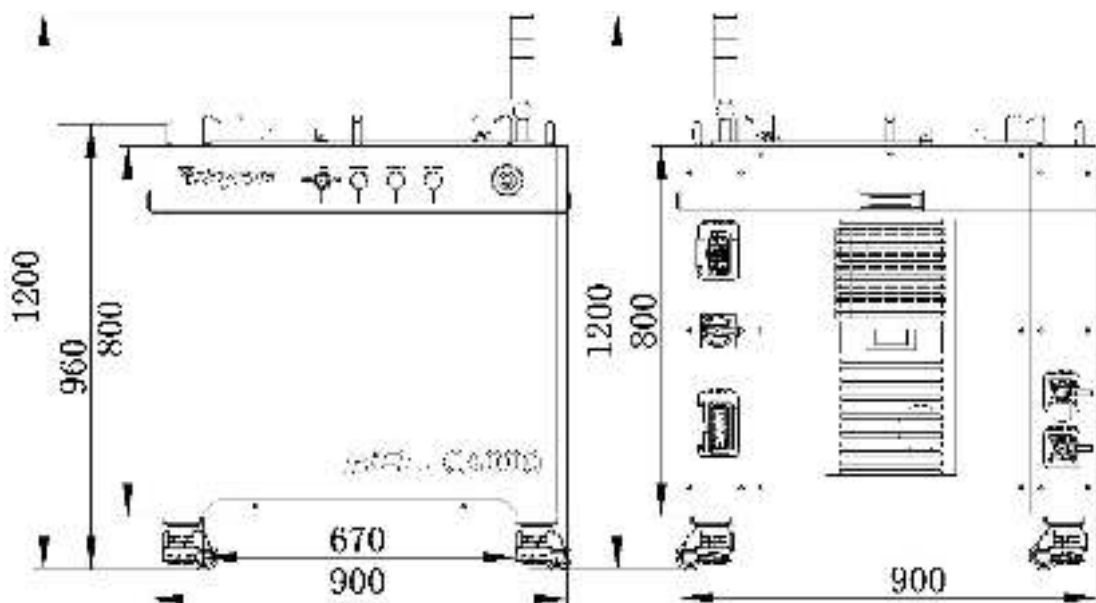

Figure 2-a Front and rear view of the laser.

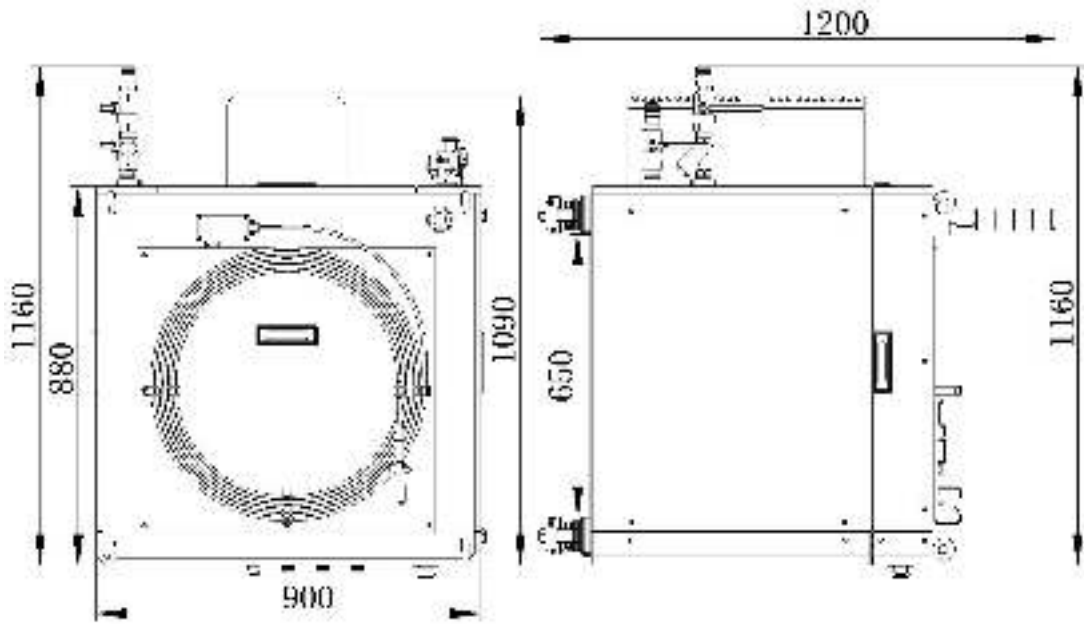

Figure 2-b Top and left view of the laser.

Figure 2 The dimensions of RFL-C6000X continuous wave fiber laser.

RFL-C6000X / C8000X two lasers share a set of cabinets.

Model	RFL-C6000X	RFL-8000X
N.W	360kg	400kg
Dimensions	900*960*1160mm(L×W×H)	

(3) The dimensions of the RFL-C10000X / C12000X continuous wave fiber lasers are shown in Figure 3 (taking RFL-C12000X as an example).

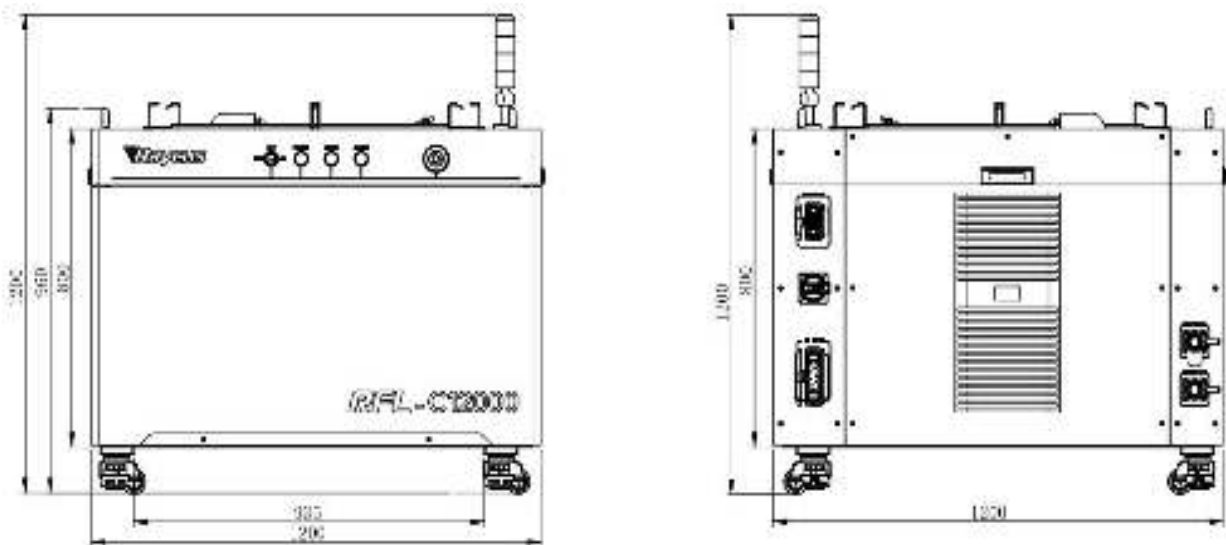

Figure 3-a Front and rear view of the laser

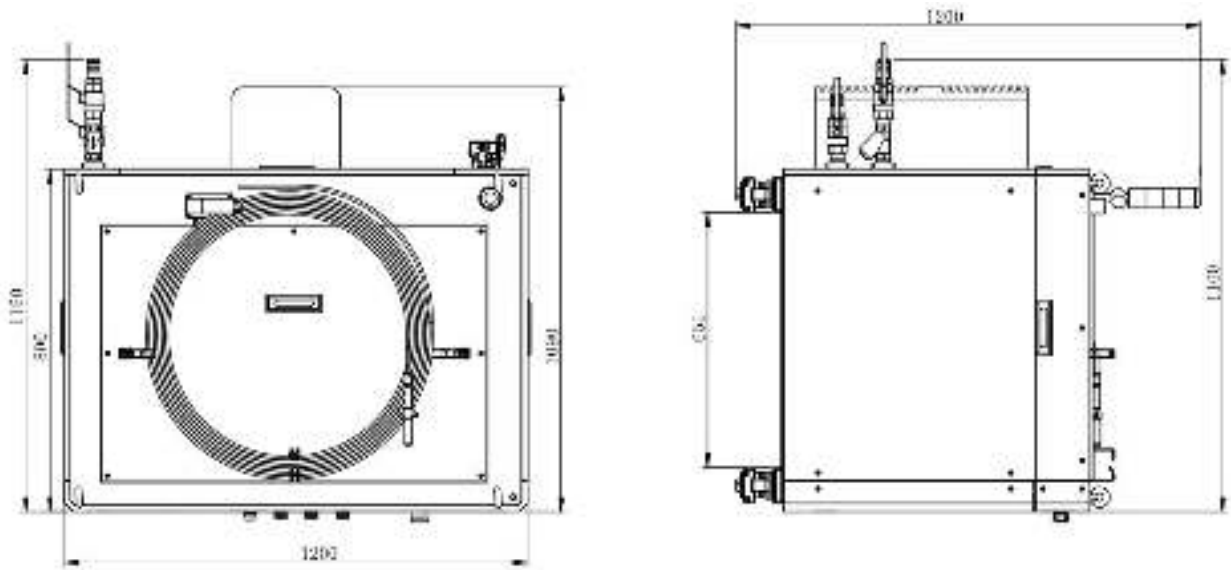

Figure 3-b Top and left view of the laser.

Figure 3 The dimensions of RFL-C12000X continuous wave fiber laser.

The RFL-C10000X / C12000X two lasers share a set of cabinets.

Model	RFL-C10000X	RFL-12000X
N.W	450kg	500kg
Dimensions	1200*960*1160mm(L×W×H)	

(4) The external dimensions of the RFL-C15000W continuous fiber laser are

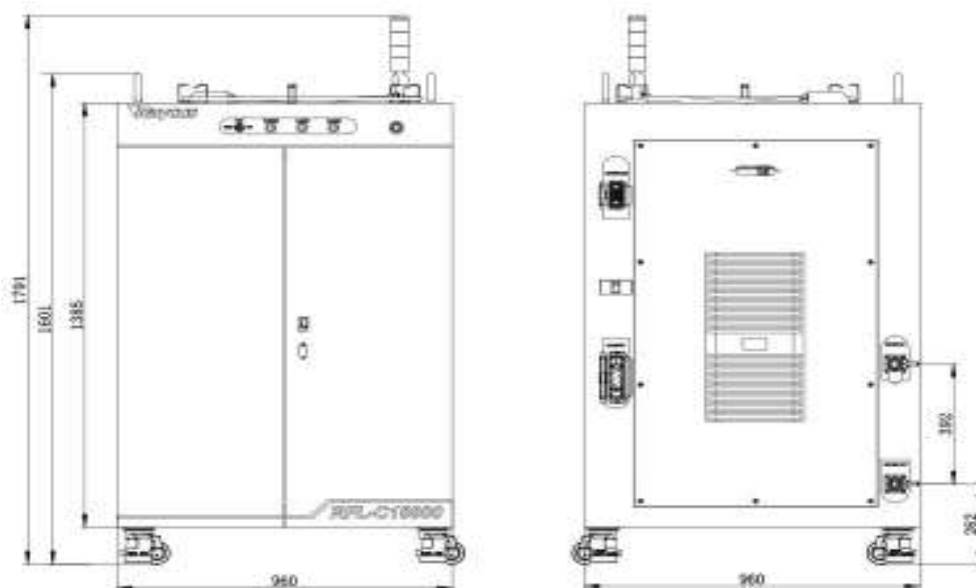

shown in Figure 4.



Figure 4-a Front and rear view of the laser

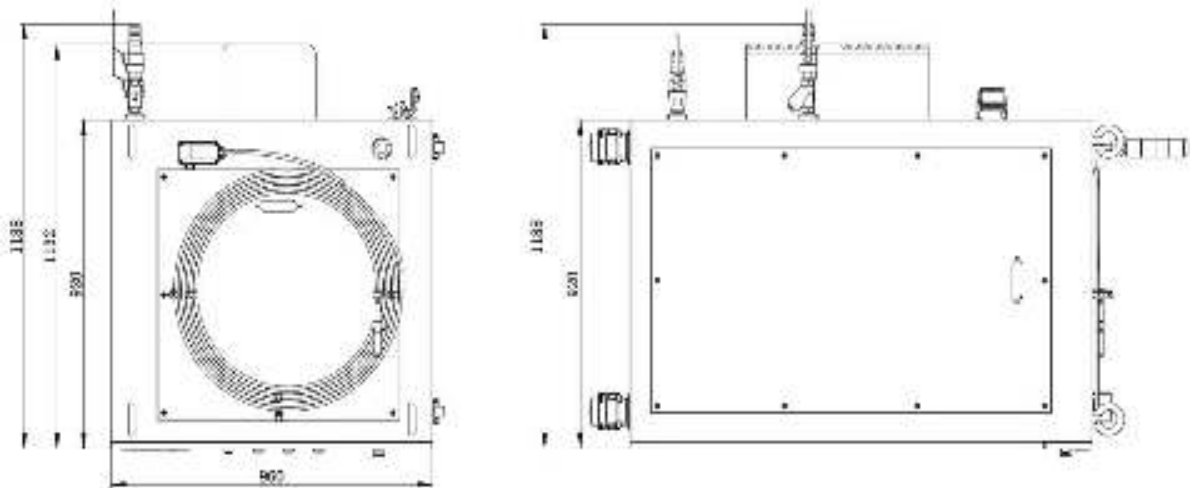

Figure 4-b Top and left view of the laser.

Figure 4 The dimensions of RFL-C15000 continuous wave fiber laser.

Model	RFL-C15000X
N.W	800kg
Dimensions	960*1600*1180mm(L×W×H)

The type and dimensions of RFL-C3300X / C4000X / C6000X / C8000X / C10000X / C12000X / C15000 continuous fiber laser output cable and output cable head are as follows:

- (1) RFL-C3300X / RFL-C4000X / RFL-C6000X lasers use RFL-HQBH output optical cable, and the dimension of output optical cable head are shown in Figure 5;

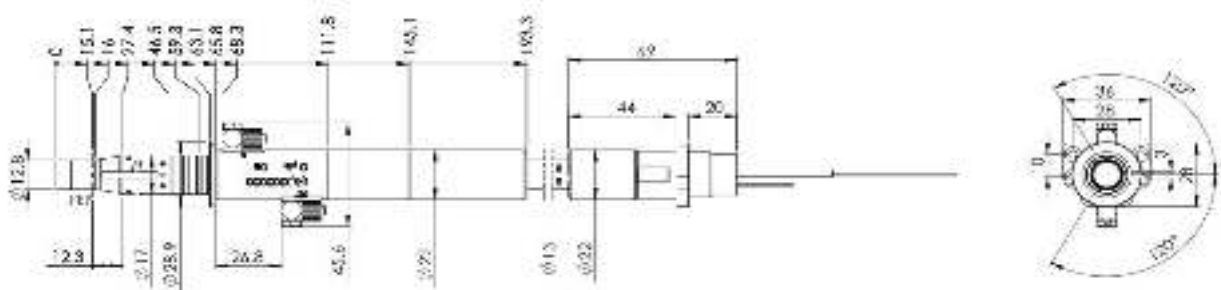
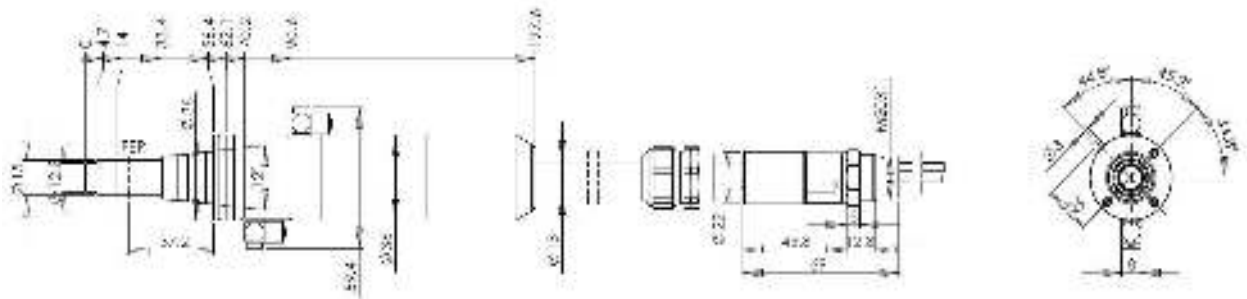

Figure 5 RFL-QBH output optical cable head



(2) RFL-C8000X / RFL-C10000X / RFL-C12000X / RFL-C15000 lasers use RFL-QD output optical cable. and the dimension of output optical cable head



are shown in Figure 6:

Figure 6 RFL-QD output optical cable head.

Note: The dimensions in the above diagram are in the unit of mm.

Before the laser works, make sure that the two copper contacts (Interlock pins) on the output head are shorted, otherwise the laser will not work properly. Before installing the output cable into the processing head, the lens of the output cable must be inspected. If the output cable lens is dirty, the lens must be cleaned. It is forbidden to disassemble the output lens by anyone other than staff in Raycus, otherwise the warranty will be invalidated.

### 3.2 Installation rule

- (1) Place the laser horizontally in a suitable position and fix it as necessary;.
- (2) Before the laser is powered on, Please check the power supply has the correct voltage (380VAC  $\pm$  10%, 50/60Hz, See Table 2 Product Technical Data Sheet for details.), please refer to the technical parameter table of Table 2 for details, whether the grounding line is well grounded.
- (3) Connect the power cable and control cable to the product when power supply is OFF.
- (4) Clamp the water pipes on topipe connector, run the chiller to check if there is any leakage in the water circulation.

- (5) Check the output head and clean it before installation. This procedure must be performed by Raycus personnel or person authorized by Raycus.
- (6) Prevent the delivery cable from treading, pinching or excessive bending during installation.
- (7) Make sure the environment is clean, or the output head may be contaminated. It is prohibited to use fan during installation, which will cause dust in the air.
- (8) The minimum bending radius of the transmission cable of the laser shall not be less than 20cm in the non-working state (such as transport and storage). The minimum bending radius should not be less than 30cm when the laser is work.
- (9) Users can employ four lifting rings or rollers on the top or bottom of the device to carry or move it, as shown in figure8 (please check whether the lifting rings are installed firmly and whether the rollers are fully mobile before transporting the device).

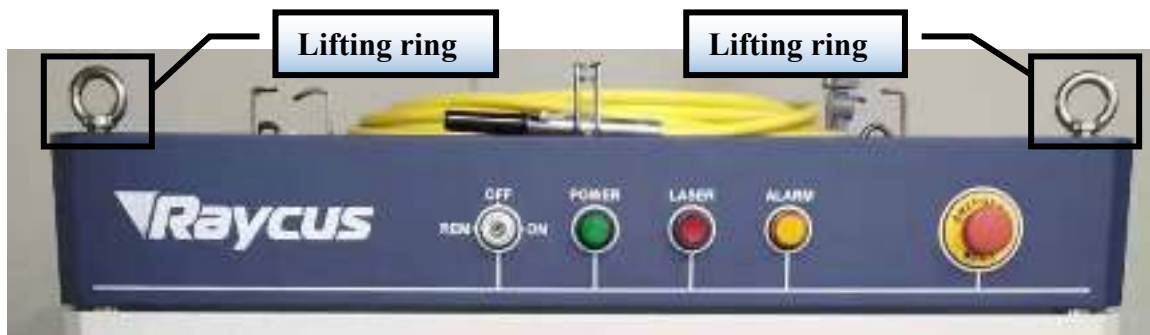

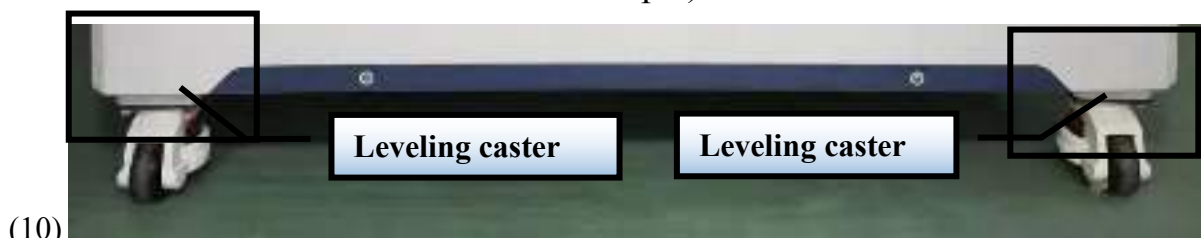

(10)a) Lifting ring (taking 4kW as an example).



b) Leveling casters (taking 6kW as an example).

Figure 7 Laser top lifting ring and bottom level adjustment caster.

	<p><b>CAUTION:</b> All the cables can only be connected when power supply is off. Hot plug may damage the device.</p>
---	---

	<p><b>CAUTION:</b></p> <p>(1) Ensure that there are no fiber bends in radius less than 30cm when the product is installed. Avoid excessive twisting and tight bends during the robotic arm movements.</p> <p>(2) Tight bends will damage the laser delivery system.</p>
---	---

	<p><b>CAUTION:</b></p> <p>(1) Keep the protective cap properly, prevent it from contamination; Or the aperture will be contaminated when capped.</p> <p>(2) Make sure the aperture and the cavity of the processing head is clean.</p>
---	--

### 3.3 Cooling Requirements

Table 3 Cooling Requirements

Product number	C3000X	C4000X	C6000X	C8000X	C10000X	C12000X	C15000
Cooling capacity (kW)	≥10	≥12	≥20	≥24	≥30	≥36	≥45
Minimum flow (L/min)	>35	>45	>52	>64	>79	>94	>112
Maximum input pressure (Bar)	7						
Hose inner diameter (mm)	Φ25				Φ32		

Cooling system water temperature setting:  $25 \pm 0.5$  °C.

Requirements on Cooling Water:

- (1) Purified water should be used.
- (2) In order to prevent the growth of mould that may lead to blockage, adding alcohol solution to about 10% of the total volume is recommended.
- (3) If ambient temperature is between  $-10^{\circ}\text{C}$  and  $0^{\circ}\text{C}$ , we recommend to use 30% alcohol(volume ratio), and replace it every 2 months.

(4) If ambient temperature is below  $-10\text{ }^{\circ}\text{C}$ , the chiller with both heating and cooling functions must be used, and keep it in full-time operation.

Requirements for output cable cooling system:

- (1) Rate of liquid flow:  $1.7\sim 2.0\text{ L/min}$ ;
- (2) Pressure of liquid flow:  $< 0.6\text{ MPa}$  at the inflow;
- (3) Type of liquid exchange junction: Two-Touch Fitting M5 to  $\phi 6$ ;
- (4) Type of tube: outer diameter  $\phi 6$ ; inner diameter  $\phi 4$ ;
- (5) Direction of cooling liquid: unidirectional; connect the tube with the water-pipe strictly according to direction shown on the layer of the tube;
- (6) Type of liquid: de-ionized water, condensed water, pure water;
- (7) PH value of liquid:  $5.5 - 9$ ;
- (8) Filter is needed for the cooling system, and the size of the solid residual practicals should be within  $100\mu\text{m}$ ;
- (9) Maximum temperature of liquid:  $45\text{ }^{\circ}\text{C}$ ;
- (10) Minimum temperature of liquid: greater than the saturated dew-point  $5\text{ }^{\circ}\text{C}$ ;
- (11) Additive to the liquid: satisfies the requirements of PH value and size of solid residual practicals as above;
- (12) Radius of the bending of the armored pipe: off-work state(i.e. transportation and reservation): minimum radius of bending  $\geq 20\text{ cm}$ ; in-work state: minimum radius of bending  $\geq 30\text{ cm}$ ;
- (13) Long-term vibration  $< 2\text{ G}$ ; Impact action  $< 10\text{ G}$ .

Other requirements:

(1) When starting the cooling system for the first time, check the entire water system and joint for water leakage. The external water pipe must be installed and connected according to the inlet (IN) and outlet (OUT) identified by the laser. Otherwise, the laser may not work properly. If the device is not use in a long time, water must be emptied from the device, and then both the inlet and outlet must be blocked with the caps. Failure to do so may cause damage to the device.

(2) If the laser is not used for a long time, the cooling water inside the cooling system and the laser inside should be drained, otherwise the laser equipment will be damaged.

(3) Please use compressed gas below 0.5MPa when emptying water from the device. Failure to do so may cause permanent equipment damage to cooling system.

	<p><b>CAUTION:</b> (1) Set the water temperature of the cooling system correctly according to the ambient temperature. Setting the water temperature too high will result in the laser not working properly. Setting the water temperature too low will cause condensation inside the laser or the laser output head, which will cause damage to the laser;</p> <p>(2) Before turning on the laser, the cooling system must be working properly and the water temperature should be suitable for the temperature.</p>
---	---

## 4 Using the Product

---

 **The Raycus continuous wave fiber laser has stopped using the HyperTerminal. After the laser is powered on, the HyperTerminal has no display. Please log in to the official website of Raycus to download the new PC software and the PC software user manual. Website: <http://www.raycuslaser.com>**

---

### 4.1 Front Panel

Figure 8 shows the front panel.

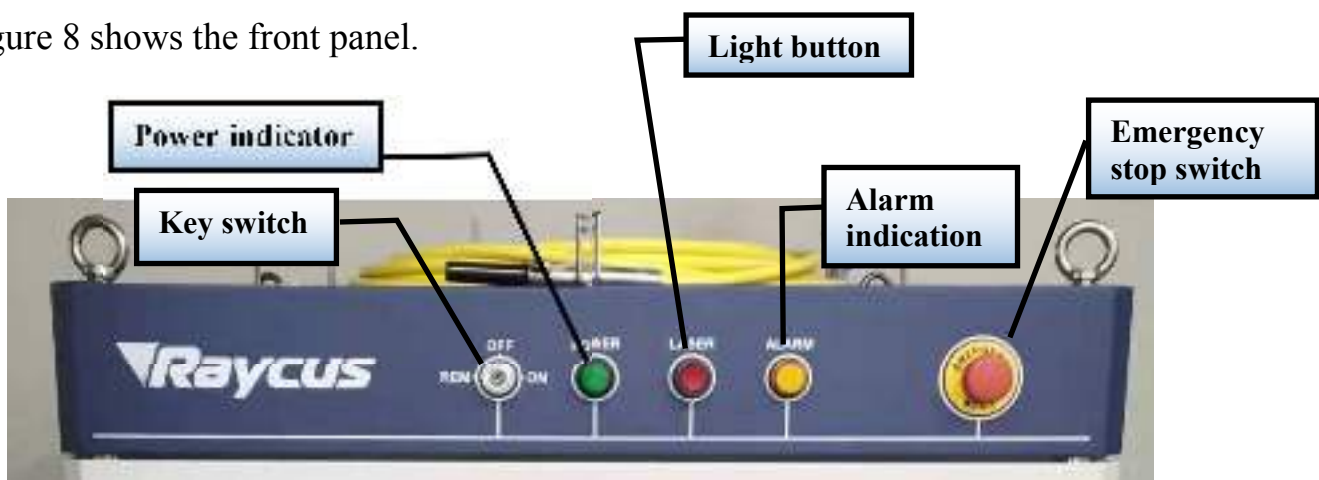

Figure 8 Front view of the panel.

**REM/OFF/ON:** Key switch, the power switch of the laser. Insert the key and then turn the key clockwise to the 'ON' position or counterclockwise to 'REM' position to active the laser. The laser then enters the corresponding control mode based on the level of the "AD/RS" in the "INTERFACE" interface and subsequent operations. You can refer to "Settings for Control Mode" for details.

**POWER:** Power Indicator, indicates that the power is switched on when the green LED illumines.

**LASER:** Light button with red light indication. In the serial debugging mode and the AD mode, press the button to ensure the laser in the light-emitting state, press it again to make the button pop up, and the laser turns off the light to enable.

**ALARM:** Alarm indicator, indicates a fault condition when the yellow LED illumines.

**EMERGENCY STOP:** Press to turn the laser off immediately and turn it clockwise to release the button. Use the key to turn the laser back on to return to normal.

**INDICATOR LIGHT:** When the laser key switch hits "ON" or "REM", the green indicator light is on. The red indicator light brights when the laser emitting. When the fault occurs, the yellow indicator light is on, accompanied by an alarm.

## 4.2 Rear Panel

Figure 9 shows the rear panel.

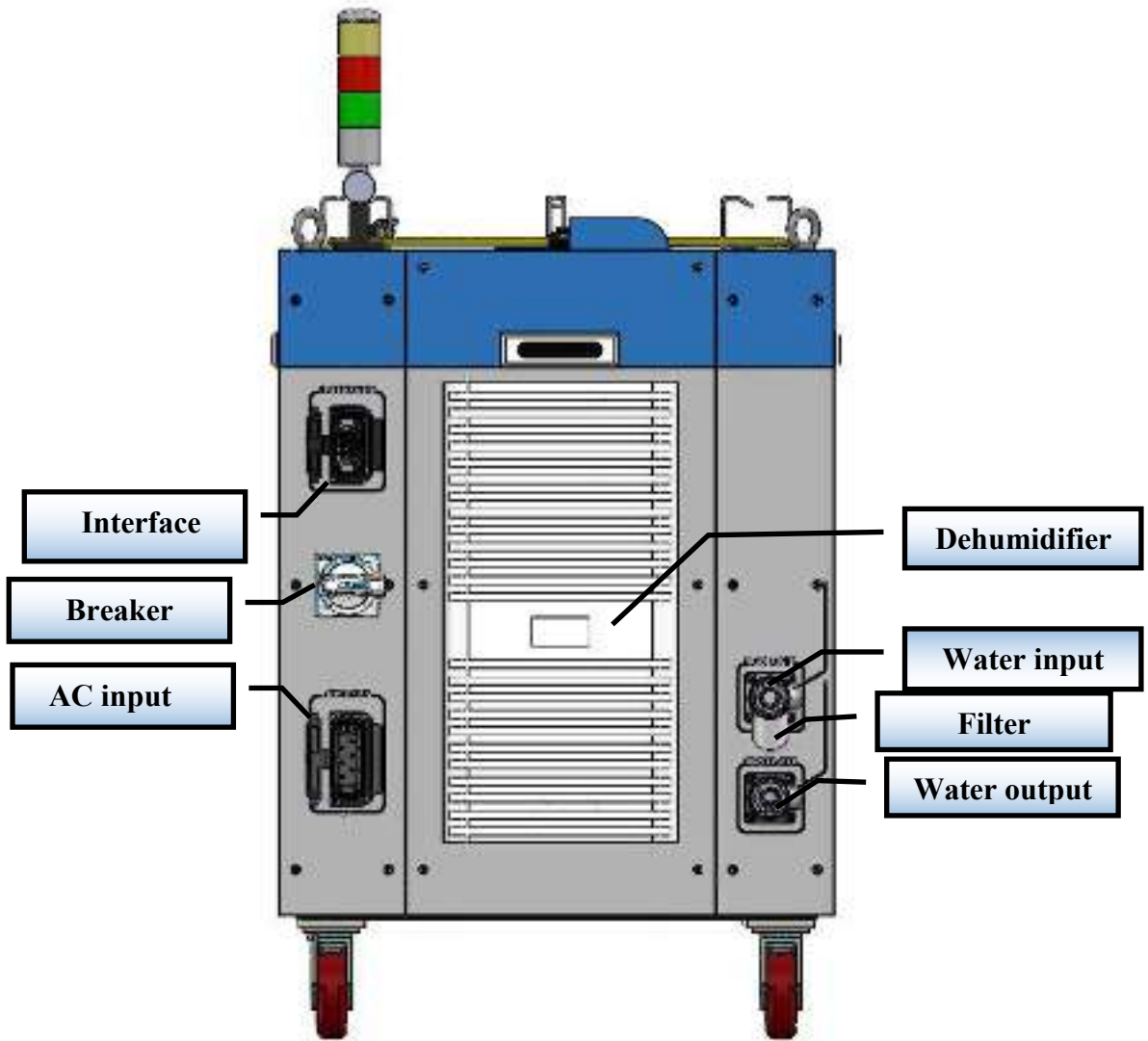
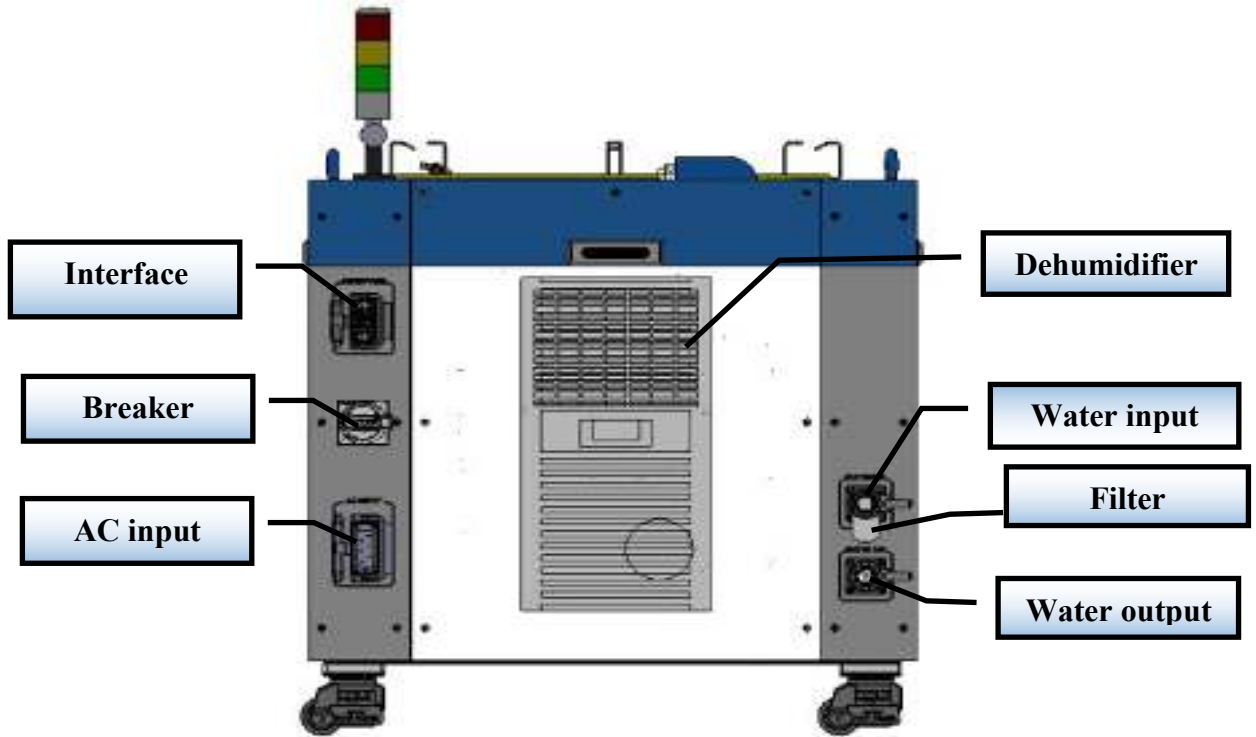
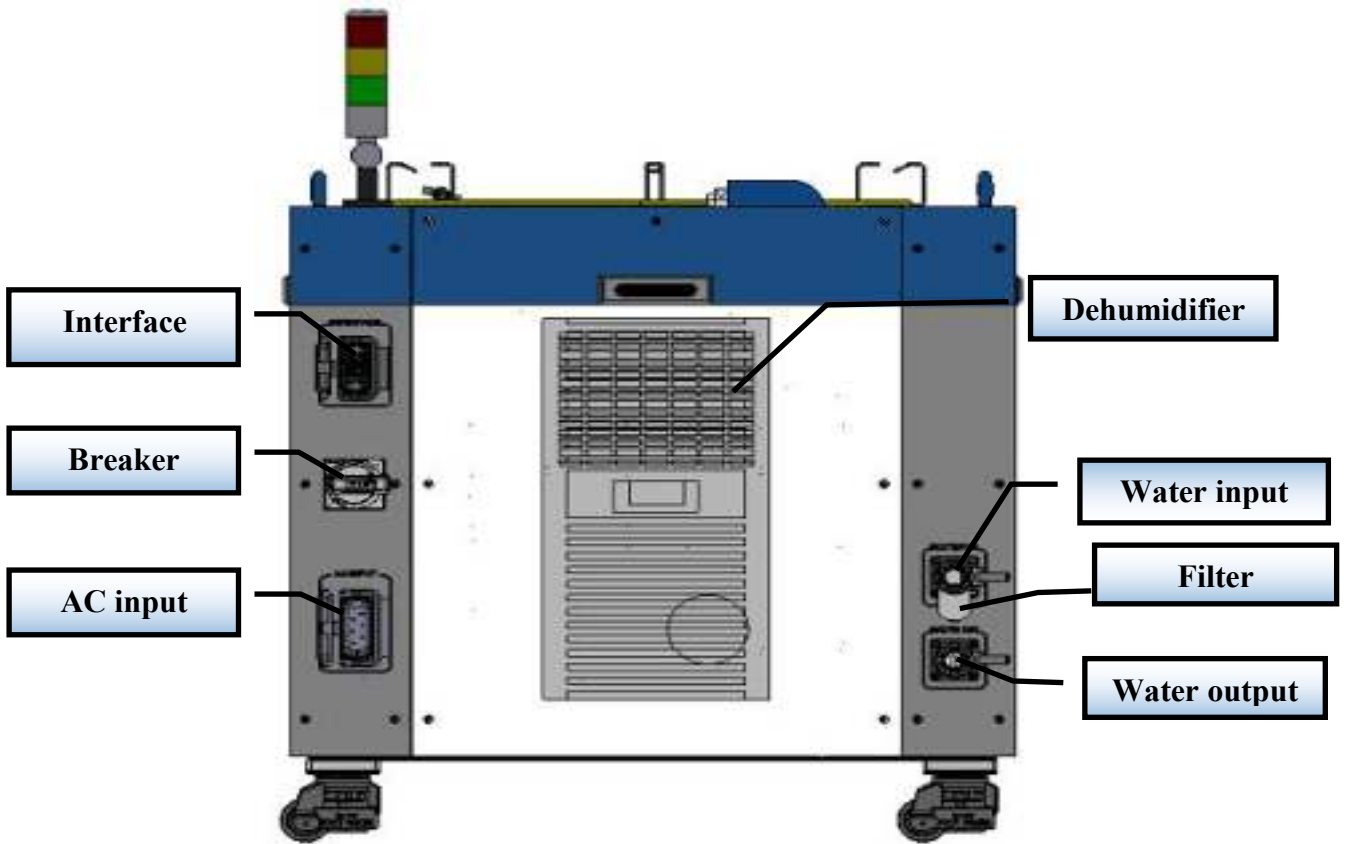

Figure 9-a Rear view of C3.3kW/C4kW product panel.





Picture 9-b Rear view of C6kW/C8kW product panel.



Picture 9-c Rear view of C10kW/C12kW product panel.



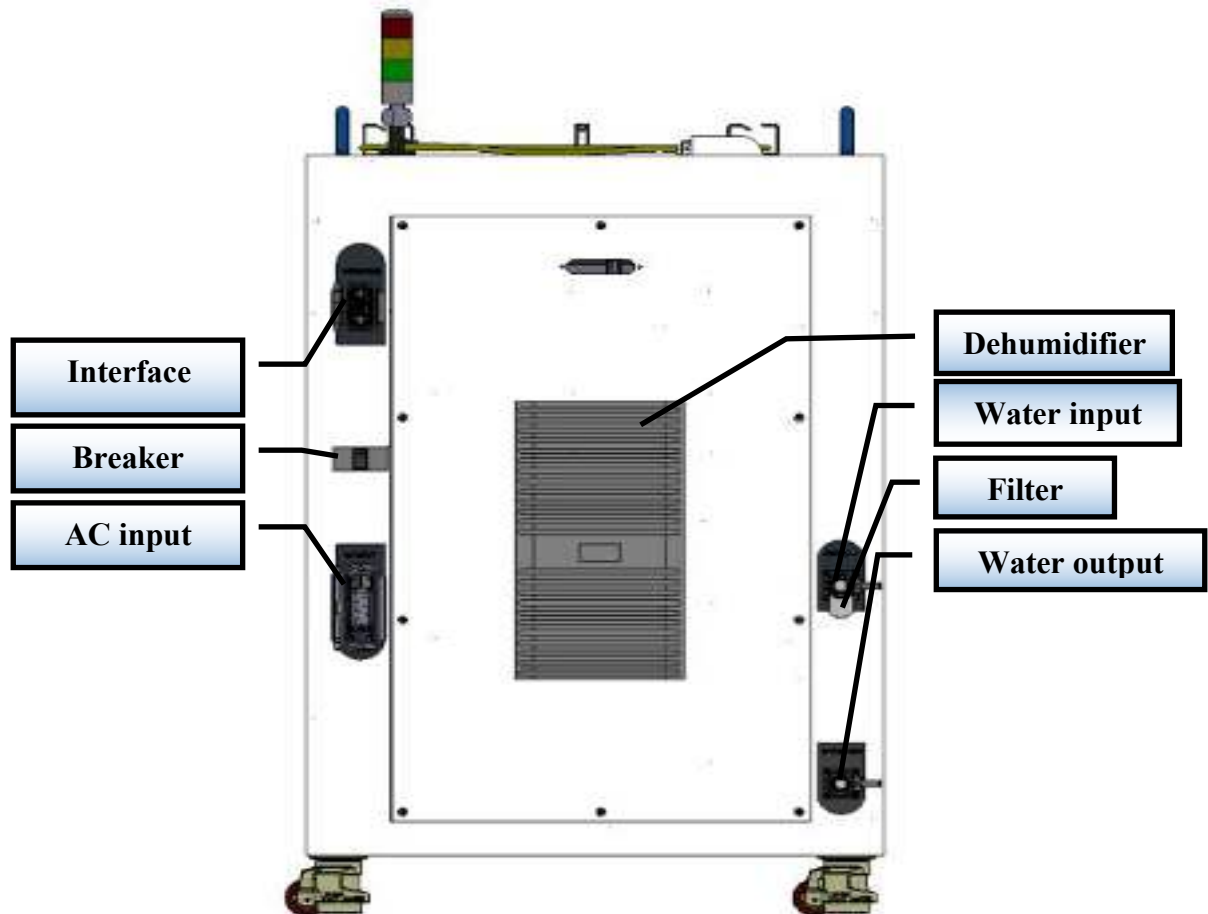

Picture 9-d Rear view of C15kW product panel.

Figure 9 The picture of laser rear panel.

**AC INPUT:** The socket for supply input that can be only mated with the plug on the power cord we provided. The socket is provided with a protective cover and a lock catch. Please use the protective cover and lock catch when not use the laser device.

**INTERFACE:** Control interface. This interface provides all control signals, including RS232 communication, laser switch control, laser remote control mode selection, analog control, modulation signal, Interlock interface. Please reference table 4 for specific definition of control line. The socket is provided with a protective cover and a lock catch. Please use the protective cover and lock catch when not use the laser device.

**WATER:** The pagoda type pipe connector. The intake and outlet are used for inflow and reflux cooling water.

The circuit breaker which is located on the side panel is the power switch of the device, as shown in Figure 9.

### 4.3 Power Connection

	<p><b>CAUTION:</b></p> <p>(1) Before connect the product to AC power, you must check up that the AC supply you will apply is in accordance with the specifications provided in Table 1.</p> <p>(2) Failure to correctly connect the cable could damage the device. Please check whether the power cable and the control cable is correctly connected before usage.</p>
---	--

A power cord is provided in the package, as in Figure 10:



a) 3.3kW / 4kW power cord. b) 6kW / 8kW / 10kW / 12kW power cord. c) 15kW power cord.

Figure 10 The Power Cord of the Laser.

The end of the power cord is a plug; insert it into the socket ‘AC INPUT’ on the rear panel when using the laser. Notice that the plug is wrong-side preventing. After insert it, lock it with the lock. As shown in Figure11.



a) The picture of 3.3kW / 4kW power port plug / socket.



b) The picture of 6kW / 8kW / 10kW / 12kW power port plug / socket.



c) The picture of 15kW power port plug / socket.

Figure 11 The Picture of power cord plug and socket.

The AC input lines of 3300W / 4000W two types laser use four-core cables, and the AC input lines of 6000W / 8000W / 10000W / 12000W / 15000W four types laser use seven-core cables. The interface definition and parameter requirements of the AC input line are shown in Table 4.

Table 4 The interface definition and parameter requirements of AC input line.

Interface definition and parameter requirements of 3300W/4000W/6000W laser AC input lines				
Connector Tag	Interface definition	Logo	Wire diameter	Wire color
1	AC380V-L1	L1	6mm <sup>2</sup> /6mm <sup>2</sup> /10mm <sup>2</sup>	Brown
3	AC380V-L2	L2	6mm <sup>2</sup> /6mm <sup>2</sup> /10mm <sup>2</sup>	Black
5	AC380V-L3	L3	6mm <sup>2</sup> /6mm <sup>2</sup> /10mm <sup>2</sup>	Gray
7	Protective Earth	PE	6mm <sup>2</sup> /6mm <sup>2</sup> /10mm <sup>2</sup>	Yellow-green
2、4、6、8	/	/	/	/
Interface definition and parameter requirements of 8000W/ 10000W/ 12000W/ 15000W laser AC input lines				
1、2	AC380V-L1	L1	6mm <sup>2</sup> /6mm <sup>2</sup> /6mm <sup>2</sup> /10mm <sup>2</sup>	Brown
3、4	AC380V-L2	L2	6mm <sup>2</sup> /6mm <sup>2</sup> /6mm <sup>2</sup> /10mm <sup>2</sup>	Black
5、6	AC380V-L3	L3	6mm <sup>2</sup> /6mm <sup>2</sup> /6mm <sup>2</sup> /10mm <sup>2</sup>	Gray
7、8	Protective Earth	PE	6mm <sup>2</sup> /6mm <sup>2</sup> /6mm <sup>2</sup> /10mm <sup>2</sup>	Yellow-green

The standard length of 3.3kW / 4kW provided by Raycus is 8 meters, and the standard length of 6kW / 8kW / 10kW / 12kW / 15kW is 15m.

#### 4.4 Interface Definitions

All control signals are shown on the “INTERFACE” port located on the the rear panel of the device. Figure 12 shows the control cord that we provide.



Figure 12 Control cord.

Please insert the control cord we supplied into the “INTERFACE” port on rear panel when using the product, and lock it, as Figure 13 shows.

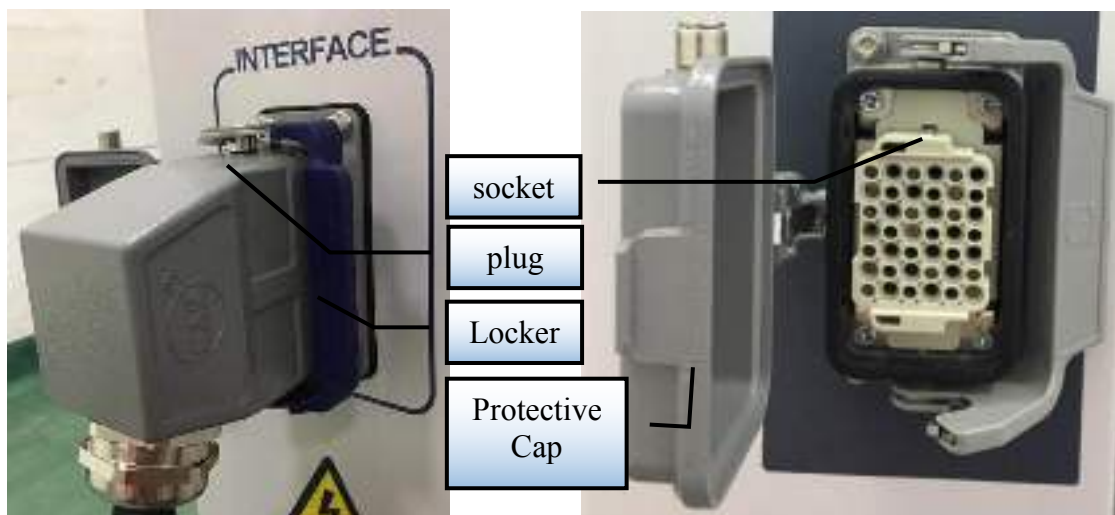

Figure 13 Control port and socket on the lock.

The control cord of “INTERFACE” port consists of five different groups of cords. The definitions of the port are in the following table.

Table 5 Definitions of Control Cord

Label	Pin #	NOTE	Color	Definition	Comment
CONTROL	6	LAS_C	White	External control of light output, high level is 24V. When the level is high, the laser emission is ready, otherwise is disabled. The function is the same as the ‘LASER’ button on the front panel. ‘LASER’ and this control signal can’t work	All reference ground in “CONTROL” cord is “EGND”



				simultaneously. If you use 'LASER', left this pin disconnected; if you use this pin to control emission, keep the 'LASER' button up ( 0->Emission Disabled; 1->Emission Ready)	
	7	AD/RS	Green	Control mode selection; the key switch is in the "REM" position, when this port is at 24V high level during the laser power-on self-test, the laser enters the external AD mode, otherwise it automatically enters RS232 mode	
	8	RDY	Black	When the system self-test is completed; when the laser system self-test is completed, this port will output 24V high level to remind you that the laser can be emitted	
	9	EGND	Blue	GND of control signal	
	20	EVCC	Red	External 24V power supply; when 24V is externally supplied to this port, the "S_ERR" and "RDY" port functions will take effect	
	24	S_ERR	Purple	Fault Signal, this signal cannot work without Pin 20 being connected to external power supply of 24V	
	\	PE	\	Protective Earth.Connecting the protective earth with the overall shield.	
POWER FEEDBACK	35	FB	Red	During the laser light extraction process, this port outputs 0~8V analog quantity according to optical power.	Power feedback analog dedicated output cable
	1	EGND	Blue	External DC power ground	
	\	PE	\	Protect the ground and connect the shield to the protective ground.	
AD	22	0-10V	Brown	Analog signal for laser power control. The laser output power is adjusted by setting the input analog voltage magnitude.	Analog input cable
	25	AGND	White	GND of Analog Voltage Signal	
	\	PE	\	Protective Earth.Connecting the protective earth with the overall shield.	

MODULATION	36	MOD+	Brown	Input port of 24V modulation signal	\
	37	MOD-	White		
	\	PE	\	Protective Earth. Connecting the protective earth with the overall shield.	
INTERLOCK	38	ITL_A	Brown	Remote protection. "ITL_A" and "ITL_B" must be shorted when the laser is powered on. Failure to do this will cause the alarm of laser.	\
	39	ITL_B	White		
RS-232	40	RX	Brown	"TX" of RS232	RS232 control
	41	TX	White	"RX" of RS232	
	42	GND	Green	Groud of RS232	
	\	PE	\	Protective Earth. Connecting the protective with overall shield.	



**CAUTION:** Please check the control voltage level and ensure that the level is in accordance with the requirements. Over voltage and voltage ripple may damage the product.

## 4.5 Operation Mode and Control

There are two different modes of operation-CW and modulation. In the CW mode, the laser emits continuously, and you can set the output power by percentage of output power. In the modulation mode, the laser emits in a waveform of pulses. The pulse can be set by the frequency, duty cycle and power percentage.

Laser power can be set in two ways: by communicating commands through a the serial port or by setting analog voltage through an external AD mode. At the same time, there are two ways of laser optical control: communication command through serial port or MODULATION signal control through the control interface.

## 4.6 Entering a Control Mode

The Figure 14 shows the process of entering a control mode.

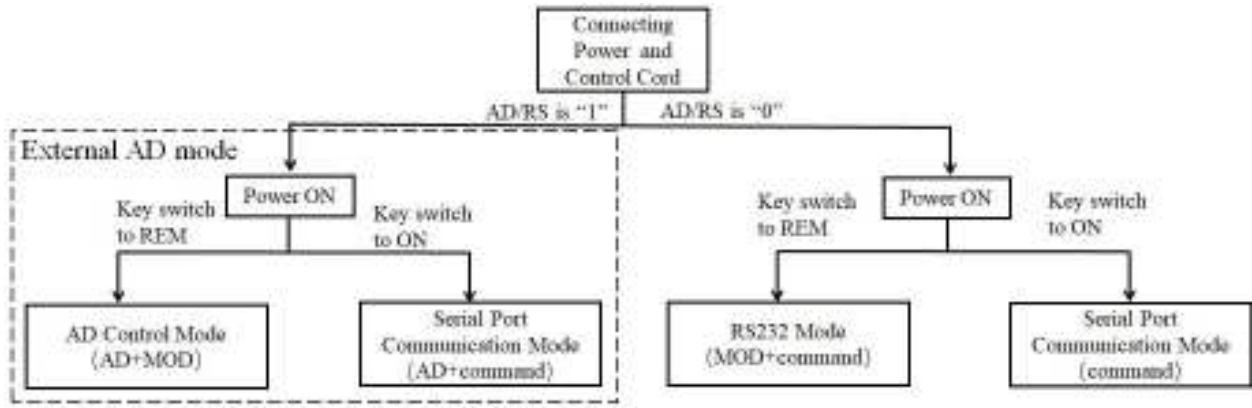

Figure 14 The process of entering a control mode.

The control modes can be divided into AD mode, serial port communication mode and RS232 mode (AD+ command) according to the different control modes of the laser output and power. In the serial port communication mode, you can choose to send commands or external AD analog voltage Settings for power control.

The laser is AD mode when PIN 7 and 9 of the control interface are connected to 24V (high level); When PIN7 and 9 of the control interface are suspended or connected to 0V (low level), the laser enters the serial port communication mode. When the key switch is placed in REM, the laser enters the external control mode. At this time, the powering on and off of the laser is controlled by the modulated signal of the control interface. When the key switch is ON, it enters the internal control mode. At this time, the laser's power on and off is controlled through the serial port communication command.

#### 4.7 Serial Port Communication Mode

In the serial port communication mode, according to communication protocol provided by RAYCUS, users can type in instruction through PC. Then operations such as setting parameters, reading laser state, and laser emission control can be executed. RAYCUS provides a software that we developed for users to check the laser state and debug simply. The installation environment of the laser client control software should be within the WINDOWS system and Microsoft. NET Framework 4.0.



### 4.7.1 Cable Connection of Serial Port Communication Mode

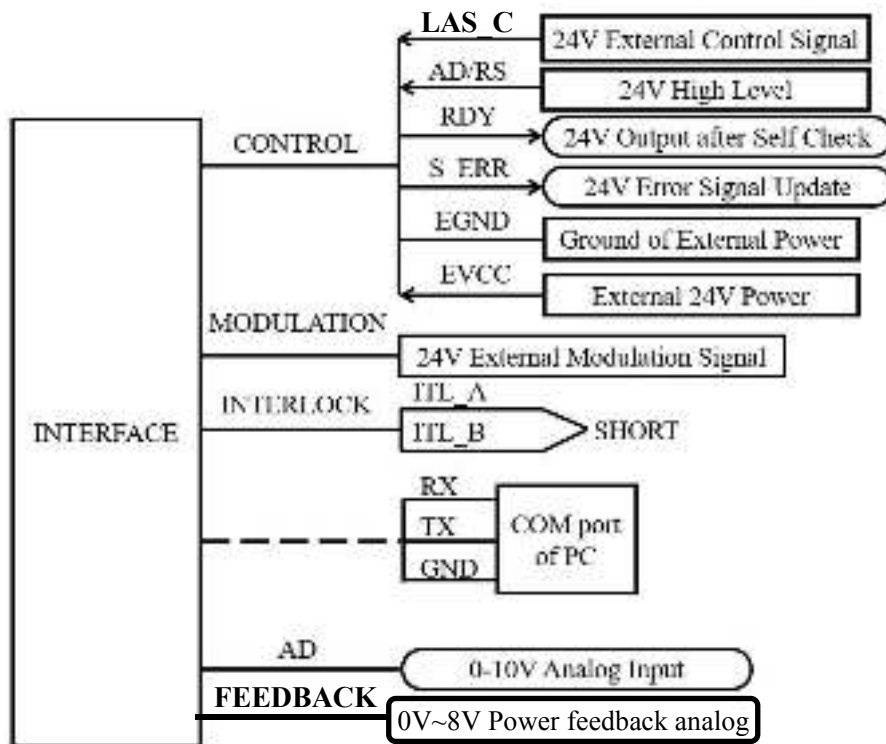

Figure 15 Wiring of Serial Port Communication Mode

### 4.7.2 Operations in Serial Port Communication Mode

Before the laser is powered on, check whether the laser status meets the following requirements:

- (1) The power wiring and control wiring are connected correctly, and the voltage meets product requirements.
- (2) Ensure the laser emission button on the front panel is released and the level of sixth pin "LAS\_C" of "INTERFACE" port on the rear panel is low.
- (3) Status of Interlock is correct..
- (4) Make sure that the water cooling system is connected. The water cooler starts to work, and the temperature of the water is at the proper working temperature (about 25°C). Check whether there is any leakage issues within entire water cooling system and the joints.

- (5) Turn the key to “ON” position, and power on the laser, then the green LED will illumine. Double click the RAYCUS laser client control software, then the following interface can be seen in Figure 16.

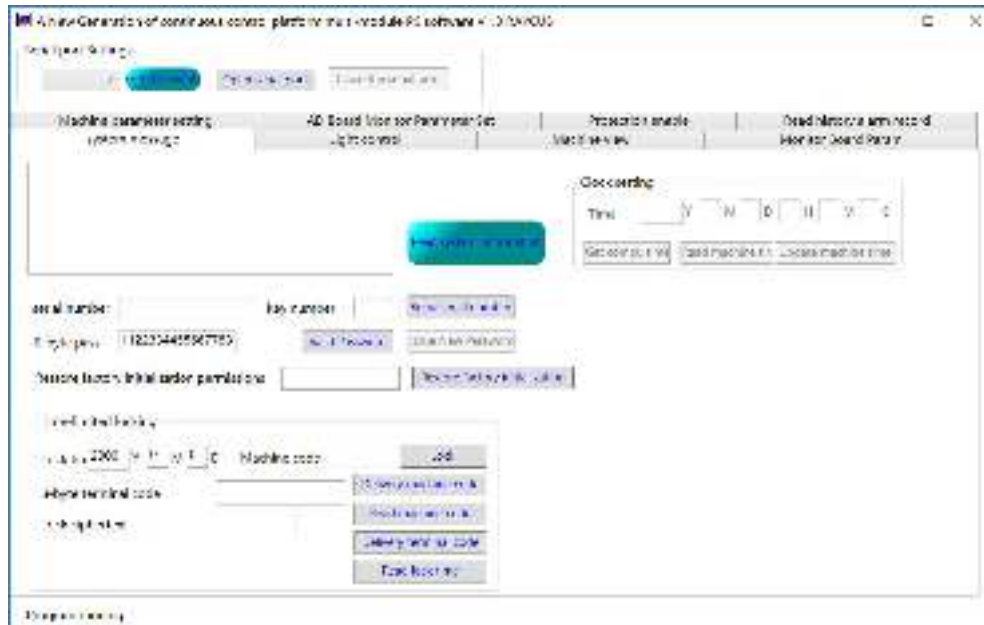

Figure 16 Interface 1 of the RAYCUS laser client control software.

After self-checking of 20 seconds, users can select the corresponding COM in the drop-down box and click “Open serial port”. Then click “Read system information”, and the relevant parameters of the laser can be read by the software and displayed on the main panel in 1 second, where the panel indicates the communication between the client control and the laser are normal. Then operations such as parameter setting、laser state reading, and laser emission controlling can be executed.

- (6) After connecting the serial port, select machine view and click “update parameter” to collect the laser state at present, in Figure 17:

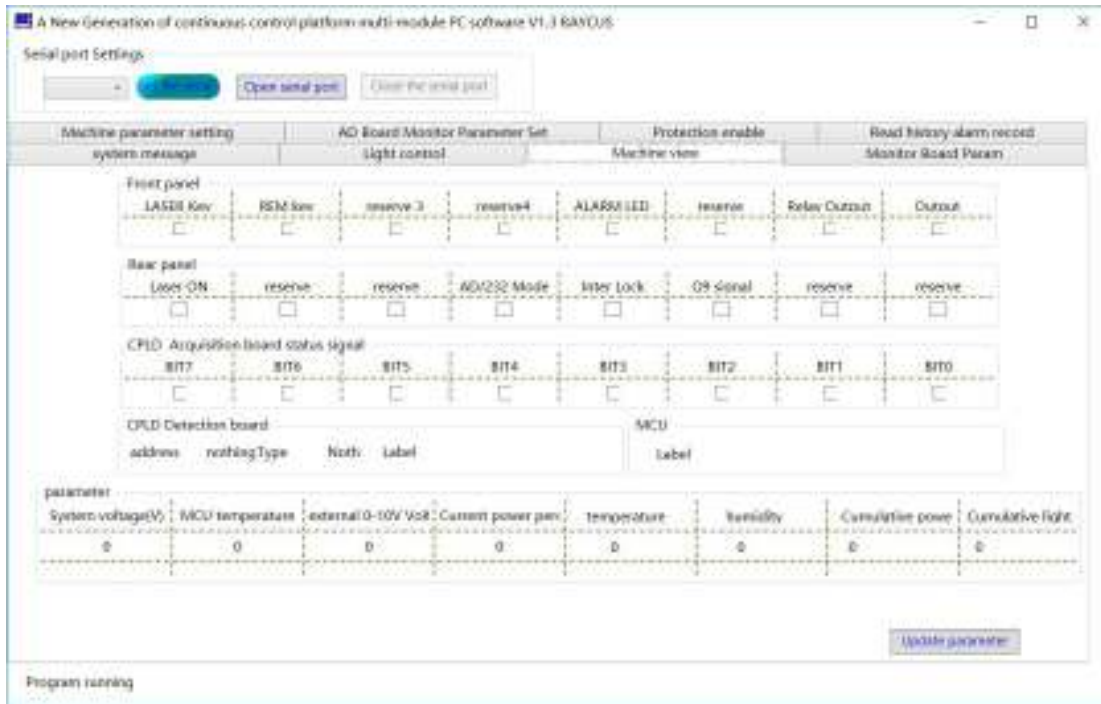

Figure 17 Inteface 2 of the RAYCUS laser client control software.

Verify that the settings are correct (if the signal is sent from front and rear panel, the corresponding status signal will be ticked) and there is no alarm information. Users can adjust the light control interface to control the laser light. After entering the light control interface, the light mode and power can be set on the left side:



Figure 18 Inteface 3 of the RAYCUS laser client control software

If users want to continuously emit laser, set the duty ratio to 100% and set the required power percentage. By clicking the “set” button, a message about the successful setting should pop up. Then clicking the light switch and pressing the Laser button on the front panel, or giving the 6-pin Interface on the rear panel a 24V signal Laser, can both generate continuous laser with previously set power. The adjusting method of the pulse output light is similar, but the corresponding frequency and duty ratio need to be set (Note: the setting range of frequency is 50Hz to 20KHz).

### 4.8 RS-232 mode

RS-232 mode is a remote control mode. In this mode, we have a protocol for communication between the laser and the PC, and you can set emission parameters and the emission switch. In addition, an external modulation signal that is laser modulation signal input port (MOD port) on the rear panel is also required to control the emission.

#### 4.8.1 Wiring in RS-232 Mode

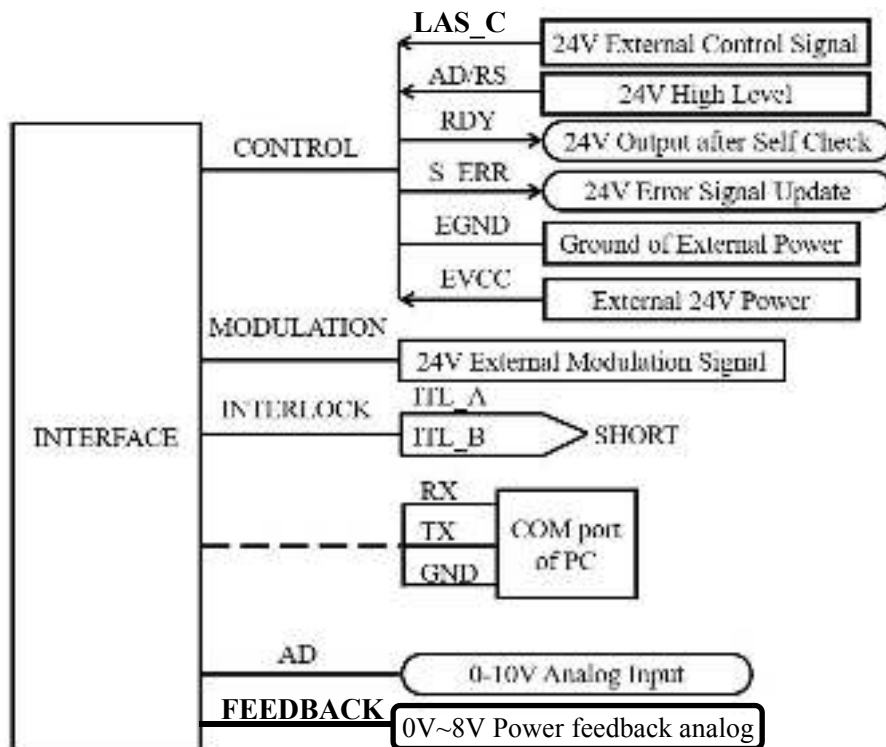

Figure 19 Wiring in RS-232 Mode

Please connect the RS-232 cable, control cable and the power cord according to the Figure 19. Make sure that the interlocking signal “ITL\_A” and “ITL\_B” in “INTERFACE” port is shorted. Confirm that the laser emission button is released and “LAS\_C” is hanging.

#### 4.8.2 Communication Protocol

This device adopts a new communication protocol, but it is also compatible with the old communication protocol. This specific protocol is attached to “the Wuhan Raycus Laser Serial Port Communication Protocol”.

#### 4.8.3 The Operation in RS-232 Mode

Before the laser is powered on, check the laser status meets the following requirements:

- 1) The power wiring and control wiring are connected correctly and the voltage meets product requirements.
- 2) Ensure Laser emission button on the front panel is released and the level of 6th pin “LAS\_C” of “INTERFACE” port on the rear panel is low.
- 3) The Status of Interlock is correct.
- 4) Make sure the water cooling connection, the water cooler starts to work and the water temperature is already at the proper working temperature (Reference cooling system requirements), and check leaks of the entire water system and joints.

After the above requirements are met. Turn the key to ‘REM’ position. The laser is powered on and the "POWER" green indicator is lit. The systems start self-check in about 30 seconds, after that, the laser will be in RS-232 mode and “RDY” signal turn to be high level.

Remark: the system ’s self-check can not pass if the "LASER" button is pressed down, the level of “LAS\_C” is high or Interlock is not shorted before self-check, and alarm LED will be lit. In this case, power off the laser and deal with the questions above, then restart the laser.

In the RS-232 mode, the conditions of laser emission are: 1) shutter is open, 2) operational parameters are set, 3) input modulation signal is on the high level.

## 4.9 AD mode

AD mode is also an external control mode. In AD mode, the output power is controlled by the external analog voltage signal.

### 4.9.1 Wiring in AD mode

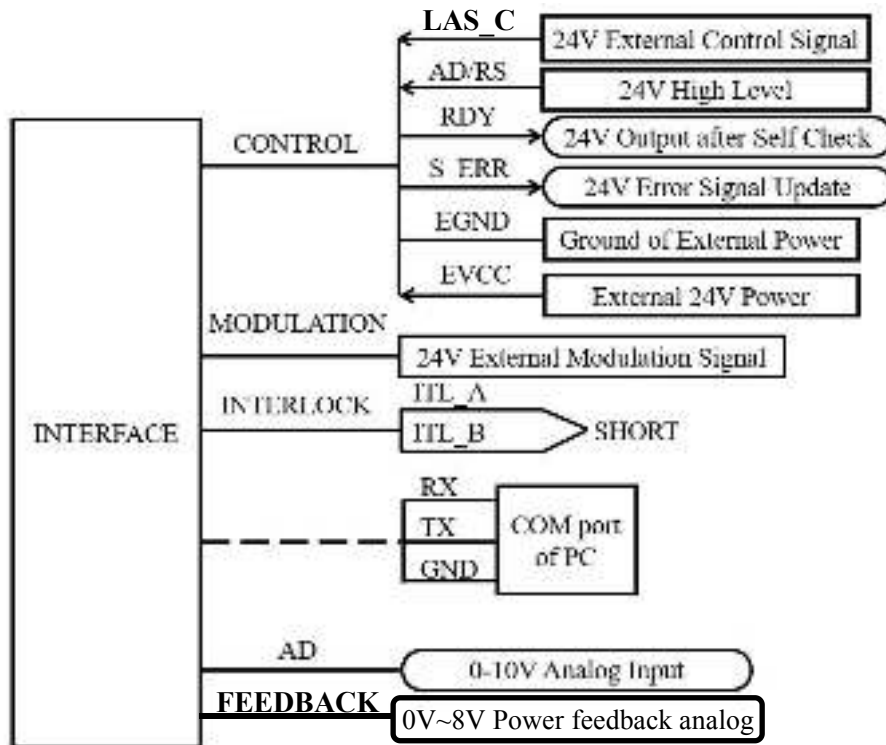

Figure 20 Wiring Diagram in AD mode.

Please connect control cable and the power cord according to the Figure 20. Make sure that the “AD/RS” is on the high level, and the interlocking signal “ITL\_A” and “ITL\_B” in “INTERFACE” port is shorted.

In AD mode, monitoring of laser states can also be opened by connecting the RS-232 cable to PC.

### 4.9.2 The operations in AD mode

Before the laser is powered on, check whether the laser status meets the following requirements:



- 1) The power wiring and control wiring are connected correctly and the voltage meets product requirements.
- 2) The “LASER” button on the front panel is up and the 6th pin “LAS\_C” of “INTERFACE” port on the rear panel is at the low level.
- 3) The interlock is shorted, and the analog signal “AD” of “INTERFACE” on the rear panel is 0V.
- 4) make sure the water cooling connection, the water cooler starts to work and the water temperature is already at the proper working temperature (Reference the cooling system requireme), and check leaks of the entire water system and joints.
- 5) Turn the key to ‘REM’ position. Power off the laser and the systems start self-check in about 30 seconds. After that, the “RDY” signal turns to be at high level, and the laser receives the analog and modulation signal.

The system self-check process cannot passe if the "LASER" button is pressed down, the“LAS\_C” of “INTERFACE” port on the rear panel is on the 24V high level, and alarm LED will be lit in yellow. In this case, power off the laser and deal with the question above, then restart the laser.

In AD mode, the laser emits if: 1) ‘LASER’ button is pressed down, or the“LAS\_C” of “INTERFACE” port on the rear panel is at 24V high level, 2) the control port of analog receives the analog signal, 3) external modulation signal is onn the high level.



◆ **CAUTION:** Please ensure that the analog signal DOES NOT exceed 10V, or product may be damaged.

#### 4.10 Red Light Control

In the series communication mode and the AD mode, Turn the key to “REM” or “ON”position. The laser is power on and “POWER” indicator is lit in green.

The red indicator indicates emission. Press the laser "LASER" button down or open the shutter through the software by serial port control to close the red light.

In RS-232 mode, Press the laser "LASER" button on or close the shutter through the software by serial port control to open the red light.

	<p>◆ <b>CAUTION:</b> Emission and red light cannot output simultaneously. If there is no red light, please check if "LASER" button pops up or the external control signal "LAS_C" at level high, or check if software controlled shutter is closed.</p>
--	---

### 4.11 Water flow monitoring

In order to ensure the normal operation of the laser, flow monitoring is installed on the RFL-C3300X/RFL-C4000X/RFL-C6000X/RFL-C8000X/RFL-C10000X/RFL-C12000X/RFL-C15000X. When the waterflow is lower than the minimum requirement, the laser will alarm. Prompt the user that the current waterflow is too low, you need to increase the waterflow to avoid damage to the laser.

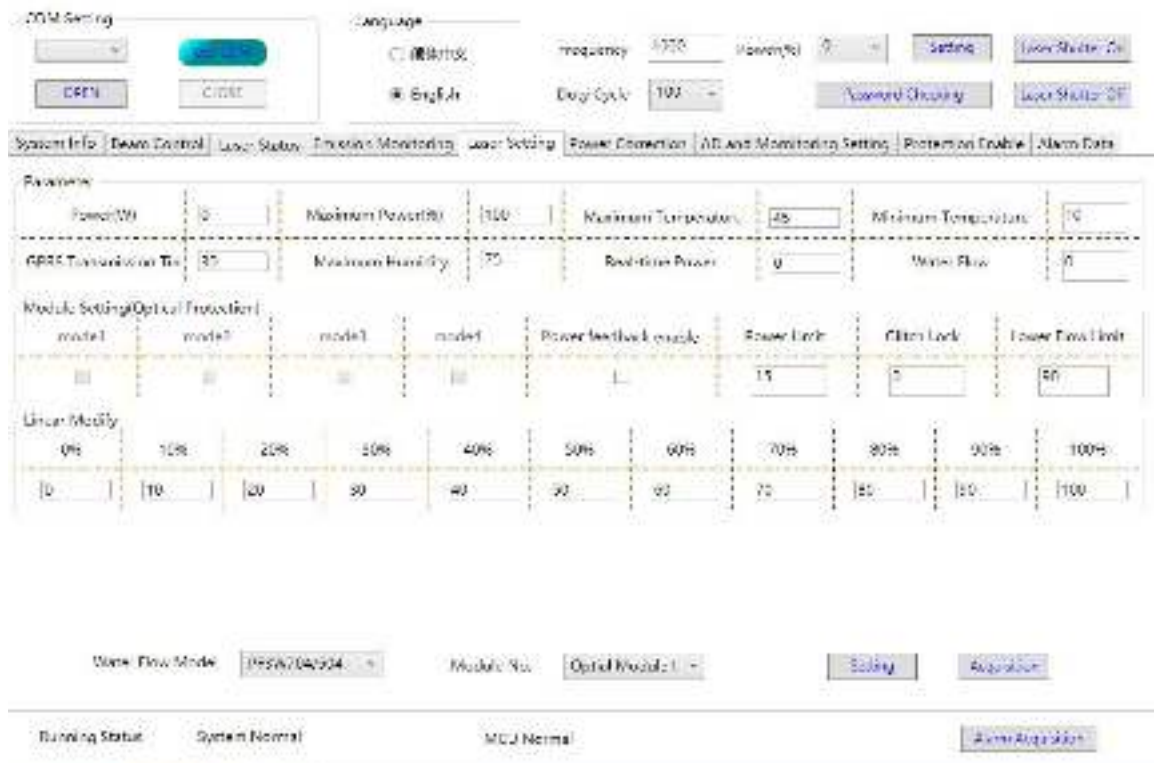

Figure 21 Schematic diagram of water flow monitoring.



As shown in Figure 21, the user can view the current real-time water flow by clicking on the read parameter in the whole machine view.

#### 4.12 Real-time power feedback

For the RFL-C8000W/RFL-C10000W/RFL-C12000W laser, the real-time power feedback function is added. When the laser emits, the real-time power of the laser can be viewed by clicking the read parameter through the interface shown in Figure 21.

#### 4.13 Light out fault locking

The default setting of the "lighting fault lockout" parameter is "2" when the laser is shipped from the factory. When using the laser, the "lighting abnormality" alarm occurs twice in succession, the laser will automatically lock and cannot emit light. Please contact Ruike related engineers for your timely resolution. As shown in Figure 21 above, the default value is locked for the light fault.

## 5 Alarms and Possible Solutions

### 5.1 Read Alarm Logs

Whenever an alarm occurs when the laser is running, the laser stops emission and is locked. At the same time the ALARM indicator (Yellow) on the front panel lights on and one string of alarm log is sent at the serial port.

Use Raycus Client Software to read the alarm log(s). Open the client software → click 'Read History Alarm Record' tab → click 'Read History Error Record' button, to read and show the latest (up to 150) alarm logs.

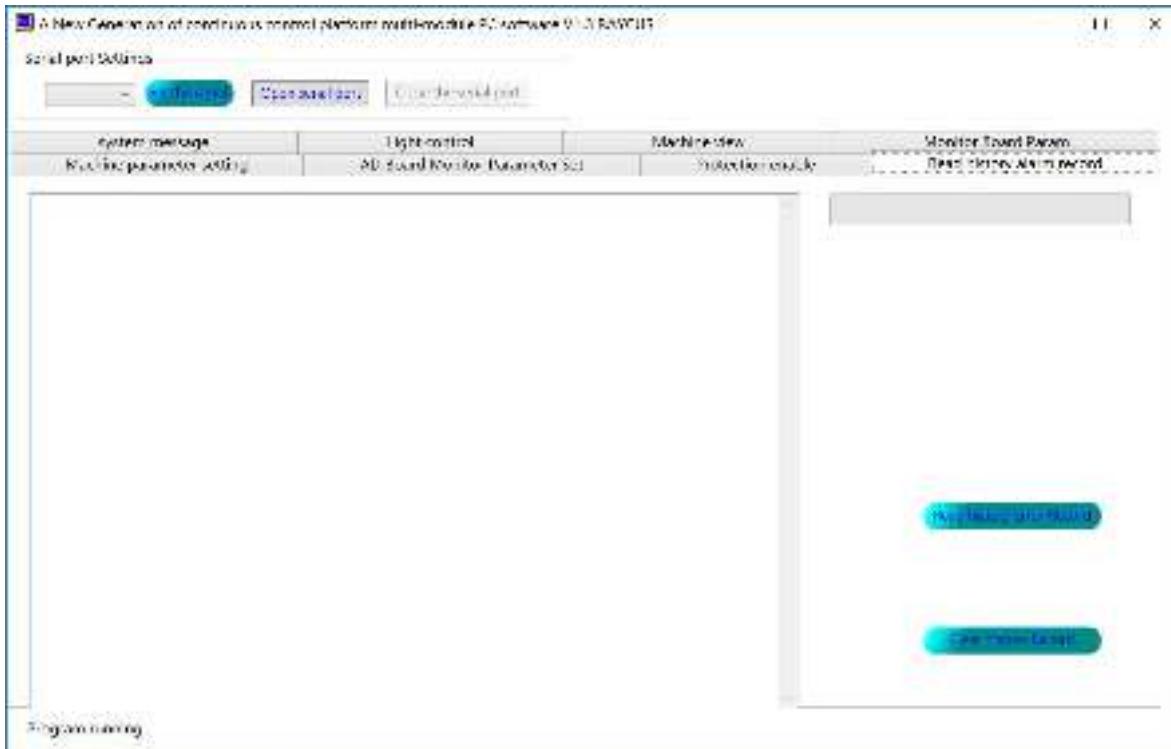

Figure 22 RAYCUS Client Software Alarm Log interface

## 5.2 Alarm Solutions

Table 6 Alarms and possible solutions

Alarm message	Error instructions and possible solutions
Temperature Error	<p><b>Instruction:</b>                      Low temperature/high temperature alarm, occurs when the temperature at the monitoring point exceeds the pre-set upper/ lower limit.</p> <p><b>Solutions:</b>                      High temperature alarm:                      Check if the water-cooling system is working normally, if the water temperature is set correctly, or if the water pipe-line connection is correct.                      When the water cooling system works normally and the water temperature drops to below 30°C, restart the laser to see if the problem is solved.                      If the alarm continues to happen, please contact Raycus.</p> <p>Low temperature alarm:                      Check if the water temperature is too low or not. Besides, a low ambient temperature may also cause a low temperature alarm when the laser is cold started. Please wait till the water temperature rises to above 10°C and then restart the device.                      If the alarm continues to happen, please contact Raycus.</p>

<p>Laser Power Error</p>	<p><b>Instruction:</b> This alarm happens when the power emission cannot reach the pre-set value. <b>Solutions:</b> Restart the device to see if the problem is solved. If this alarm continues to happen, please contact Raycus.</p>
<p>Interlock Error</p>	<p><b>Instruction:</b> Occurs when the InterLock connection is open. <b>Solutions:</b> Short circuit the InterLock pins (Pin “ITL_A” and “ITL_B”, refer to Table 5 for more info) and restart the laser. If this alarm continues to happen, please contact Raycus.</p>
<p>Laser Emission Error</p>	<p><b>Instruction:</b> This alarm happens when the laser cannot detect any laser light output. <b>Solutions:</b> Restart the Device. If this alarm continues to happen, please contact Raycus.</p>
<p>Waterflow Error</p>	<p><b>Instruction:</b> This alarm happens when the laser outward water flow is below the minimum flow requirement of the laser. <b>Solutions:</b> Increase the inward water flow of the laser. Check Table 1 for more info. After calibrating the water flow, restart the laser to see if the problem is solved. If this alarm continues to happen, please contact Raycus.</p>
<p>Power Supply Error</p>	<p><b>Instruction:</b> AC/DC1 Error. Laser power supply out of work or sudden power disconnect of the power supply system may cause the alarm. <b>Solutions:</b> Check if the input AC voltage is normal. Restart the laser to see if the problem is solved. If this error continues to occur, please contact Raycus.</p>

In addition to the above, if there are any other questions or errors, please contact Raycus service team for help.

## 6 Warranty, Repair and Return

### 6.1 General Warranty

Raycus warrants that all Raycus fiber laser products are conformed to applicable product specifications under normal use and are free from defects in materials and workmanship

Raycus has the right to selectively repair or replace any product that has a material or technical problem during the warranty period. All products repaired or replaced during the warranty period only provide free warranty services for products with special problems. Raycus reserves the right to collect payment for products that have problems under normal use.

### 6.2 Limitations of Warranty

The warranty does not cover the maintenance or reimbursement of our product of which the problem results from tampering, disassembling, misuse, accident, modification, unsuitable physical or operating environment, improper maintenance, damages due to excessive use or not following the instructions caused by those who are not from Raycus. The customer has the responsibility to understand and follow this instruction to use the device. Any damage caused by fault operating is not warranted. Accessories and fiber connectors are excluded from this warranty.

According to the warranty, client should write to us within 31days after the defect is discovered. This warranty does not involve any other party, including specified buyer, end-user or customer and any parts, equipment or other products produced by other companies.



**WARNING:** It is the customer's responsibility to understand and follow operating instructions in this User Guide and specifications prior to operation. Failure to do so may void this warranty. Accessories and fiber connectors are not covered by this warranty.

### 6.3 Service and Repair

- Do not open the device. There are no user serviceable parts, equipment or assemblies for user in this product. All service and maintenance shall be performed by qualified Raycus personnel.
- Please contact Raycus as soon as possible when problems under warranty about maintenance happened to the product.
- The product returned with permission should be placed in a suitable container.
- If any damage happened to the product, please notify the carrier in document immediately.

**Raycus reserve the right to make changes in design or constructions of any of our products at any time without incurring any obligation to make changes or install the same on units previously purchased.**

**All the items about warranty and service above provided by Raycus are for uses' reference; formal contents about warranty and service are subject to the contract.**